

BOURDON
The Original by Baumer



Main Features

- Excellent repeatability
- Dead band adjustment for regulation
- Fix dead band for control and alarm
- Light weight
- Explosion proof Hazardous areas 1, 2, 21, 22

Applications

- Power generation safety equipment
- Water treatment
- Valve and compressor control

Technical Data

Temperature range	-46 ... 0 °C to 160 ... 250 °C	Electrical connection	Via internal terminal block with cable gland 3/4 NPT certified ATEX/IECEX for Ø7 to 12 mm cable
Temperature	Process : -46 ... +250 °C Ambient : -20 ... +70 °C (T5) -20 ... +60 °C (T6) Storage : -40 ... +70 °C	Electrical function	See ordering code details page 5
Repeatability	± 1% F.S. / constant temperature cycle	Adjustment	Internal adjustment possible for set point and dead band
CE conformity	Low Voltage Directive 2014/35/EU ATEX Directive 2014/34/EU	ATEX/IECEX	<u>Certificate</u> LCIE 02 ATEX 6219X IECEX LCIE 15.0059X <u>Classification</u> CE II 2 G D Ex d IIC T6 or T5 Gb Ex tb IIIC T80 °C or T95 °C Db
Protection rating	IP 66 (EN 60529)		
Process connection	Stainless steel 1.4404 (316L)		
Bulb	Stainless steel 1.4404 (316L) bulb Ø 9.5 mm		
Scale	Internal graduated scale		
Weight	2.00 kg + transmission		
Housing	Grey painted aluminum housing Explosion proof		
Mounting	Wall mounting 2 x M6 x 16 screws		
Ground connection	Via internal or external terminal block		

Options

Customer specific set point adjustment	Code SETP
Mounting on 2" pipe	Code 0407
Stainless steel tag plate and wire	Code 9941

Principle

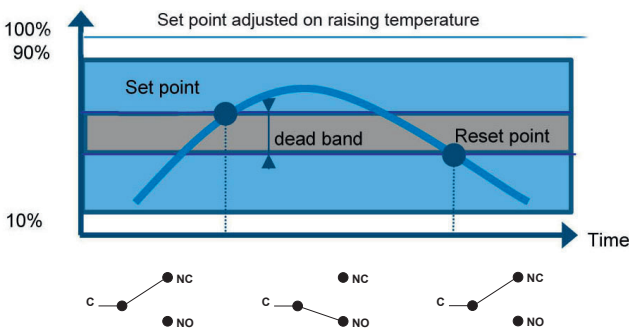
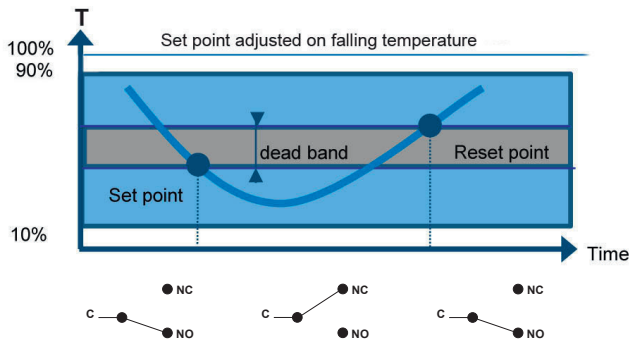

A vapour filled flexible sensing element actuates a microswitch by means of a piston. The set point is adjusted by means of a compressible spring installed in opposition.

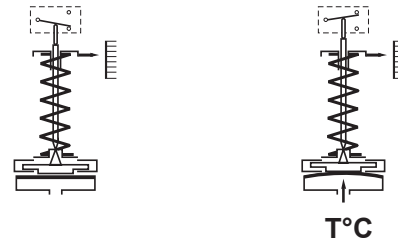

Set point and reset point must be between 10% and 90% of the selected scale.

Standard factory adjustment

Setpoint at 50% of the scale on falling temperature

Customer specific factory adjustment (option SETP)

The following specifications have to be given with the order:

- Setpoint value
- Adjustment on falling or raising temperature
- Dead band value (as needed) when using an adjustable dead band switch

Adjustable ranges

Scale	T max	Code	Micro-switch dead band ¹⁾							
			Adjustable dead band		Fixed dead band					
			R		L		M - P		U (2 x SPDT)	
°C	°C		10%	90%	10%	90%	10%	90%	10%	90%
			°C	°C	°C	°C	°C	°C	°C	°C
-46 ... 0	40	40	4 - 7.5	2.5 - 6.5	1	1	5	4	5	5
-20 ... 20	60	41	2.5 - 5.5	2 - 6.5	1	1	5	4	5	5
0 ... 45	80	42	3 - 6	2.5 - 7	1	0.5	3.5	3	5	2.5
40 ... 120	145	43	5.5 - 10.5	3 - 8.5	1.5	1	6	6	7.5	5
100 ... 180	190	44	6 - 12	4 - 7.5	1.5	1	7	5.5	7.5	5
20 ... 90	120	45	6.5 - 12.5	4 - 8	2	1.5	11	11	10	7.5
160 ... 250	290	46	6 - 11	4 - 11	1.5	1	6.5	5	7.5	5
70 ... 150	175	48	9.5 - 18.5	5.5 - 10.5	1.5	1.5	11	8	7.5	7.5

¹⁾ The value of the dead band is depending on the value of the set point.

This table contains the dead band values for set point adjustment at 10% and 90% of the selected scale. For adjustable dead band the lower value correspond to the dead band spring totally released and the higher correspond to the dead band spring fully tensed. For other set points the dead band value can be calculated by linear interpolation between the values at 10% and 90%.

Micro switches characteristics

Switch code	R	L	M	P	U
Type	Adjustable dead band	Fixed dead band			
		Standard	Gold contact	Ultra sensitive	Double
6 Vdc	0.4 ... 10 A	N/A	10 ... 50 mA	0.4 ... 4 A	0.4 ... 10 A
12 Vdc	0.4 ... 10 A	N/A	10 ... 50 mA	0.4 ... 4 A	0.4 ... 10 A
24 Vdc	0.4 ... 5 A	N/A	10 ... 50 mA	0.4 ... 4 A	0.4 ... 6 A
30 Vdc	0.4 ... 5 A	N/A	10 ... 50 mA	0.4 ... 2 A	0.4 ... 6 A
48 Vdc	0.4 ... 5 A	N/A	10 ... 50 mA	N/A	0.4 ... 6 A
110 Vdc	0.1 ... 0.5 A	N/A	10 ... 50 mA	N/A	0.4 ... 0.5 A
220 Vdc	0.1 ... 0.25 A	N/A	10 ... 50 mA	N/A	0.1 ... 0.25 A
115 Vac	0.4 ... 10 A	0.4 ... 10 A	10 ... 50 mA	N/A	0.4 ... 10 A
250 Vac	0.2 ... 10 A	0.2 ... 10 A	N/A	N/A	0.2 ... 10 A
Dielectric rigidity between contacts and ground	2000 V	2000 V	2000 V	1000 V	2000 V

Electrical connections

1 SPDT

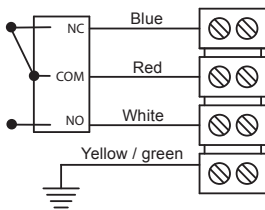

2 SPDT

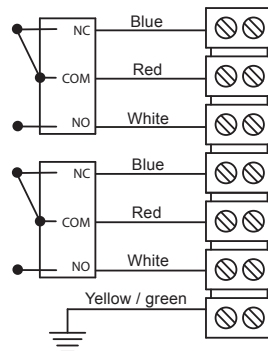

Hazardous areas : zone 1, 2, 21, 22

-20 °C ≤ Ta ≤ +70 °C	Dust IP6x	Gases
	T° surface	Class
Ta = 60 °C	80 °C	T6
Ta = 70 °C	95 °C	T5

Important : Maximum power dissipated inside enclosure does not exceed 5 W

All necessary measures must be taken by the user, to avoid the calorific transfer from the fluid to the apparatus head increasing the head's temperature to such that it reaches the self-ignition temperature of the gas in which it is used.

Dimensions (mm)

Direct mount temperature switches

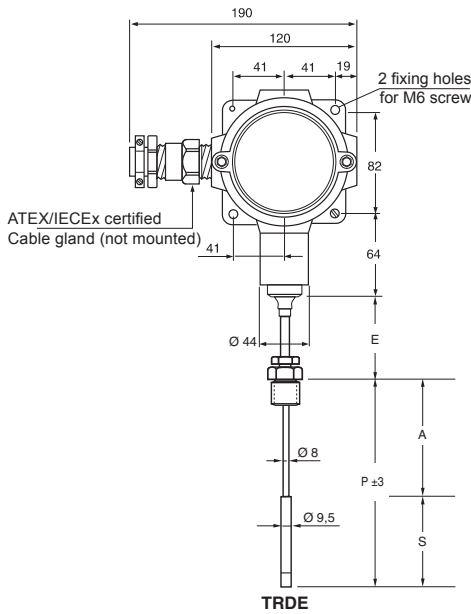

Temperature switches with capillary

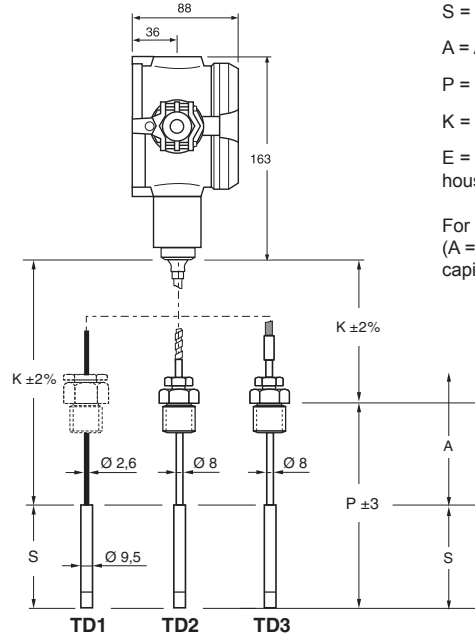

S = Bulb length (temperature sensitive part)

A = Additional stem length (min. 25 mm)

P = Immersion length ($P = S + A$)

K = Capillary length (only TD1, TD2, TD3)

E = Extension between process connection and housing only TRDE1 and TRDE2

For version TD1 there is no additional stem length ($A = 0$). The sliding connection is mounted on the capillary.

Stainless steel sliding male connection (TD2/3, TRDE1/2)

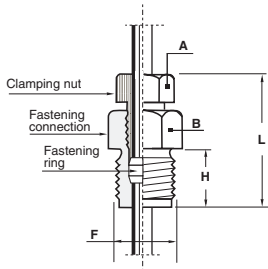

Thread and sizes		
F	G 1/2	1/2 NPT
H	18	21
L	36	40
A	17/flat	17/flat
B	23/flat	23/flat

After tightening of the clamping nut, the stem is fixed in the process connection. Tight up to 40 bar.

Stainless steel sliding male connection (TD1)

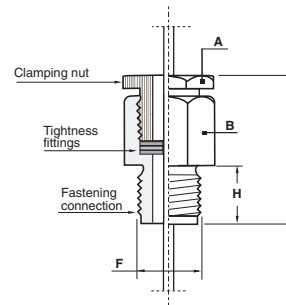

Thread and sizes		
F	G 1/2	1/2 NPT
H	18	21
L	43	46
A	27/flat	27/flat
B	27/flat	27/flat

Waterproof after tightening mounted on the capillary.

Bulb length (S) according to the capillary length (K) and the temperature range (code)

	Capillary	Code	40	41	42	43	44	45	46	48
TRDE1	n/a	S / mm	100	100	100	100	n/a	100	n/a	n/a
TRDE2	n/a	S / mm	100	100	100	100	100	100	100	100
TD1, TD2, TD3	K = 1...4 m	S / mm	100	100	100	100	100	100	100	100
TD1, TD2, TD3	K = 5...7 m	S / mm	100	150	150	100	100	150	100	100
TD1, TD2, TD3	K = 8...10 m	S / mm	100	200	200	100	100	200	100	100

Versions with S = 150 mm or S = 200 mm are not feasible with P = 150 mm

Ordering details RT2E

		RT2	-		.		.					/
Model												
Compact temperature switch		RT2	-		.		.					/
Approvals												
ATEX/IECEX Explosion proof		E										
Pressure switches												
1 SPDT standard change over switch		L										
1 SPDT gold contact change over switch		M										
1 SPDT hermetically ultra sensitive change over switch		P										
1 SPDT change over switch with adjustable dead band		R										
2 SPDT double change over switch		U										
Temperature range (°C)												
-46 ... 0		40										
-20 ... 20		41										
0 ... 45		42										
40 ... 120		43										
100 ... 180 (not for TRDE1)		44										
20 ... 90		45										
160 ... 250 (not for TRDE1)		46										
70 ... 150 (not for TRDE1)		48										
Type of transmission												
TD1 Stainless steel capillary without protection		1										
TD2 Stainless steel capillary with stainless steel protection		2										
TD3 Stainless steel capillary with stainless steel protection and PVC coating		3										
TRDE1 Rigid transmission with E=65 mm for temperature measurement below 120 °C		C										
TRDE2 Rigid transmission with E=120 mm for all temperature measurement		D										
Capillary length (K)												
Direct mounting (for TRDE1 and TRDE2)		0										
1 meter		1										
2 meters		2										
3 meters		3										
4 meters		4										
5 meters		5										
6 meters		6										
7 meters		7										
8 meters		8										
9 meters		9										
10 meters		A										
Immersion length (P)		Immersion length (P) = Bulb length (S) + additional stem length (A)										
P = S + 25 mm (minimum additional stem length A = 25 mm, for S see table on page 4)		0										
P = 150 mm (not for TD1)		3										
P = 250 mm (not for TD1)		4										
P = 400 mm (not for TD1)		5										
P = 600 mm (not for TD1)		6										
P = 1000 mm (not for TD1)		D										
Bulb diameter												
Ø 9.5 mm		C										
Process connection												
Without		0										
G1/2 male (standard)		3										
1/2 NPT male		6										
Options to be added behind the / (see example below)												

Ordering example with options

	RT2	-	E	L	.	40	.	2	1	3	C	3	/	9941
Compact temperature switch	RT2	-			.		.						/	
ATEX/IECEX Explosion proof			E											
1 SPDT standard change over switch				L										
Temperature range -46 ... 0 °C					.	40	.							
Transmission TD2							.	2						
Capillary 1 meter									1					
Immersion length 150 mm										3				
Bulb Ø 9.5 mm											C			
Process connection G 1/2												3		
Option : Stainless steel tag plate and wire													/	9941