



BOURDON
The Original by Baumer



Main Features

- Excellent repeatability
- Dead band adjustment for regulation
- Fix dead band for control and alarm

Applications

- Power generation safety equipment

Technical Data

Temperature range	-46 ... 0 °C to 40 ... 120 °C		Ground connection	Via internal terminal block
Temperature	Process:	-46 ... +120 °C	Electrical connection	Terminal block with plastic cable gland for Ø 7 to 10.5 mm
	Ambient:	-30 ... + 55 °C	Electrical function	See ordering code details on page 5
	Storage:	-40 ... + 55 °C	Adjustment	2 external adjustment screws on top of the case for set point and dead band
Repeatability	± 1% F.S. / constant temperature cycle			
CE conformity	Low Voltage Directive 2014/35/EU			
Protection rating	IP 66 (EN 60529)			
Process connection	RTA:	Copper alloy		
	RTN:	Stainless steel 1.4404 (316L)		
Bulb	Stainless steel 1.4435/1.4404 (316L)			
Scale	Internal. Accuracy on reading ± 5% F.S.			
Weight	2 kg			
Cover	Zamak blue painted Captive stainless steel screws			
Case	Black Zamak			
Mounting	Direct mounting or with wall mounting bracket			

Options

Customer specific set point adjustment	Code SETP
Stainless steel tag plate and wire	Code 9941
Lead seal of the adjustment screws	Code 8990
Nuclear cleanliness (RTN only)	Code 0838
Electrical connection: stainless steel connector (Souriau)	Code 2298
Mobile plug for stainless steel connector (Souriau)	Code 2249

Principle

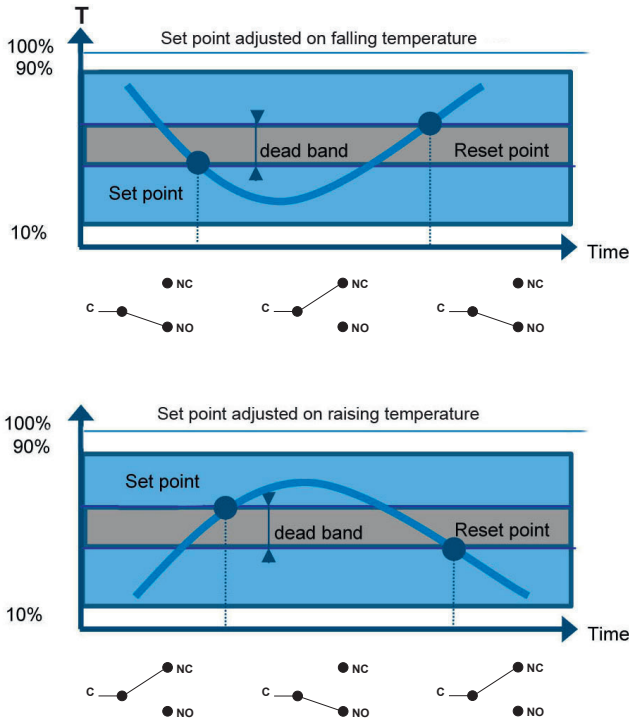

A vapour filled flexible sensing element actuates a microswitch by means of a lever. The set point is adjusted by means of a compressible spring installed in opposition.

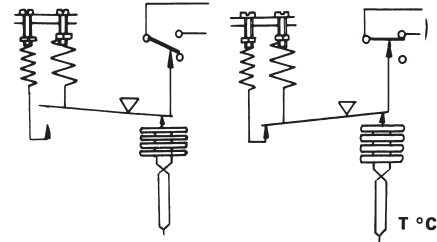

Set point and reset point must be between 10% and 90% of the selected scale.

Standard factory adjustment

Setpoint at 50% of the scale on falling temperature

Customer specific factory adjustment (option SETP)

The following specifications have to be given with the order:

- Setpoint value
- Adjustment on falling or raising temperature
- Dead band value (as needed) when using an adjustable dead band switch

Electrical connections

1 SPDT

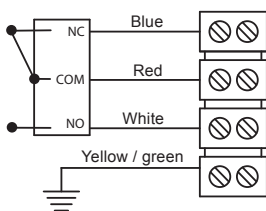

2 SPDT

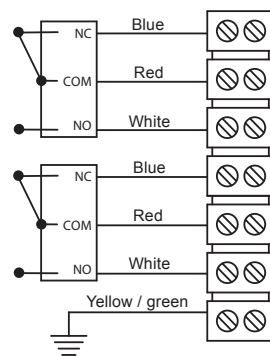

Micro switches characteristics

Switch code	A (B)	M (K)	C (W)	E (F)	H	D (V)	J
Type	Standard	Gold contact	Hermetic	Ultra sensitive	Manual reset	Ultra sensitive Hermetic	Manual reset
6 Vdc	0.4 ... 10 A	10 ... 50 mA	5 mA ... 4 A	0.4 ... 1 A	N/A	0.4 ... 4 A	N/A
12 Vdc	0.4 ... 10 A	10 ... 50 mA	5 mA ... 4 A	0.4 ... 1 A	N/A	0.4 ... 4 A	N/A
24 Vdc	0.4 ... 6 A	10 ... 50 mA	5 mA ... 4 A	0.4 ... 1 A	0.1 ... 8 A	0.4 ... 4 A	0.1 ... 8 A
30 Vdc	0.4 ... 6 A	10 ... 50 mA	5 mA ... 3 A	0.4 ... 1 A	0.1 ... 8 A	0.4 ... 2 A	0.1 ... 8 A
48 Vdc	0.4 ... 6 A	10 ... 50 mA	5 mA ... 3 A	N/A	N/A	N/A	N/A
110 Vdc	0.1 ... 0.5 A	10 ... 50 mA	5 mA ... 1 A	N/A	N/A	N/A	N/A
220 Vdc	0.1 ... 0.25 A	10 ... 50 mA	5 mA ... 0.5 A	N/A	N/A	N/A	N/A
115 Vac	0.4 ... 10 A	10 ... 50 mA	50 mA ... 3 A	0.4 ... 10 A	0.1 ... 10 A	N/A	0.1 ... 10 A
250 Vac	0.2 ... 10 A	N/A	50 mA ... 2.5 A	0.2 ... 10 A	0.1 ... 5 A	N/A	0.1 ... 5 A
Dielectric rigidity between contacts and ground	2000 V	2000 V	1500 V	2000 V	2000 V	1000 V	2000 V

Adjustable ranges

Scale	T _{Max} accidental	Code	Micro-switch dead band ⁽¹⁾										
			Adjustable dead band				Fixed dead band						
			A (B*)		M (K*)		C (W*)		E (F*)		H	D (V*)	J
			10%	90%	10%	90%	10%	90%	10%	90%	10%	90%	
°C													
-46 ... 0	40	300	4 - 9	2 - 9	8 - 12	4 - 12	1.5	0.8	5	2.5			
-20 ... 20	60	301	3 - 8	1.5 - 8	6 - 12	4 - 12	1	0.5	4	2			
0 ... 45	60	302	4 - 9	2 - 9	7 - 12	4 - 12	1.5	0.7	5	2.5			
40 ... 120	145	303	5 - 16	3 - 16	10 - 20	6 - 20	2	1.2	6	4			
20 ... 80	100	315	5 - 12	3 - 12	9 - 15	5 - 15	2	1	6	3			

(*) For version with 2 microswitches lower values of the dead band must be multiplied x 1.5

⁽¹⁾ The value of the dead band is depending on the value of the set point.

This table contains the dead band values for set point adjustment at 10% and 90% of the selected scale. For adjustable dead band the lower value corresponds to the dead band spring totally released and the higher corresponds to the dead band spring fully tensed. For other set points the dead band value can be calculated by linear interpolation between the values at 10% and 90%.

Dimensions (mm)

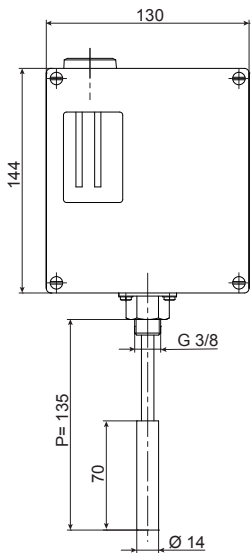
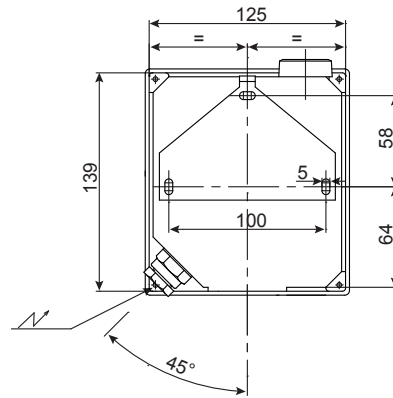
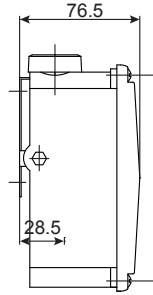
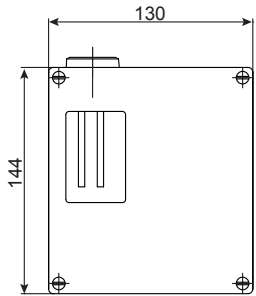

Thermowell
Thermowell for RTxx3
Stainless steel
Ordering code: 10271317

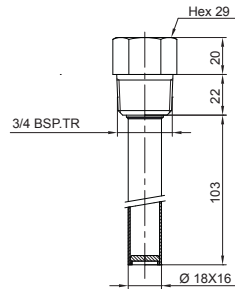

Ordering details RTNA3 - RTAA3

	RT	-	A	A	A	.	3xx	.	E	0	0	E	J	/	
Model	RT	-													
Industrial temperature switch															
Type of the bulb															
Stainless steel bulb + copper alloy connection			A												
Stainless steel bulb + connection			N												
Approval															
Standard version without ATEX approval				A											
Type of micro switches															
Deadband															
1 SPDT standard changeover switch													A		
2 SPDT standard changeover switch													B		
1 SPDT hermetically changeover switch													C		
2 SPDT hermetically changeover switch													W		
1 SPDT ultra sensitive changeover switch													E		
2 SPDT ultra sensitive changeover switch													F		
1 SPDT hermetically, ultra sensitive changeover switch													D		
2 SPDT hermetically, ultra sensitive changeover switch													V		
1 SPDT gold contact changeover switch													M		
2 SPDT gold contact changeover switch													K		
1 SPDT changeover switch, manual reset, opening on raising pressure													H		
1 SPDT changeover switch, manual reset, opening on falling pressure													J		
Temperature range (°C)															
-46 ... 0															300
-20 ... 20															301
0 ... 45															302
40 ... 120															303
20 ... 80															315
Type of design															
Direct mounting (TRD)															E
Capillary length															
Without capillary															0
Stem length P															
P=135 mm															0
Bulb diameter															
Ø 14 mm															E
Process connection															
G3/8															J

Options to be added behind the / (see example below)

Ordering example with options

	RT	-	A	A	A	.	300	.	E	0	0	E	J	/	SETP	_	9941
Industrial temperature switch																	
Stainless steel bulb + Copper alloy connection			A														
Without ATEX approval																	
1 SPDT standard changeover switch																	
Temperature range -46 ... 0 °C																	
TRD direct mounting																	
Without capillary																	
Immersion length P=135 mm																	
Bulb diameter Ø 14 mm																	
Process connection G3/8																	
Option: Customer specific set point adjustment																	
Option: Stainless steel tag plate and wire																	